

JHB15N60FE/JHG15N60FE/ JHP15N60FE

Product Preview

600V 15A FIELD-STOP TRENCH IGBT WITH DIODE

Features

- Low $V_{CE(sat)}$
- Fast Switching
- High Ruggedness
- Short-circuit Rated



Product Summary	
V_{CES}	600V
I_C	15A
$V_{CE(sat),typ}$	1.5V ($T_J = 25^\circ C$)
Package	JHB15N60FE: TO-263 JHG15N60FE: TO-220MF JHP15N60FE: TO-220

Applications

- Home Appliances
- Compressors / Air Conditioning
- Motor Control
- General Purpose Inverters

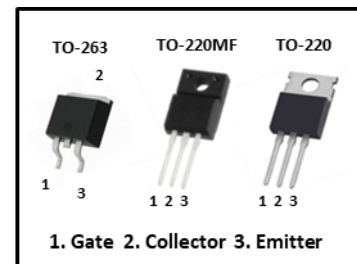
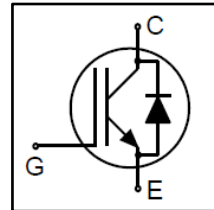

Ordering Information

Part Number	Marking	Package	Packing
JHB15N60FE	HB15N60FE	TO-263	Tube
JHB15N60FE_R	HB15N60FE	TO-263	Tape and reel
JHG15N60FE	HG15N60FE	TO-220MF	Tube
JHP15N60FE	HP15N60FE	TO-220	Tube

Absolute Maximum Ratings

Parameter		Symbol	Limit	Unit
Collector-to-Emitter Voltage		V_{CES}	600	V
Gate-to-Emitter Voltage		V_{GES}	± 20	
DC Collector Current ($T_c = 90^\circ\text{C}$, limited by max T_j)	TO-263, TO-220	I_C	20.6	A
	TO-220MF		15.8	
Pulsed Collector Current (pulse width limited by max T_j)		I_{CM}	60	
Diode Forward Current ($T_c = 90^\circ\text{C}$, limited by max T_j)	TO-263, TO-220	I_F	20 ⁽³⁾	
	TO-220MF		15.5	
Diode Pulsed Current (pulse width limited by max T_j)		I_{FM}	60	
Maximum Power Dissipation ($T_c = 25^\circ\text{C}$, $T_j = 150^\circ\text{C}$)	TO-263, TO-220	$P_{D(max)}$	114	W
	TO-220MF		74	
Operating Junction Temperature		T_j	-40 to +150	$^\circ\text{C}$
Storage Temperature		T_{stg}	-40 to +150	

Static Electrical Characteristics ⁽¹⁾

Parameter	Symbol	Test Conditions	Min	Typ	Max	Unit
Collector-to-Emitter Breakdown Voltage	BV_{CES}	$V_{GE} = 0V, I_C = 250\mu\text{A}$	600	-	-	V
Collector-to-Emitter Leakage Current	I_{CES}	$V_{CE} = 600V, V_{GE} = 0V$	-	-	10	μA
		$V_{CE} = 600V, V_{GE} = 0V$ $T_j = 125^\circ\text{C}$	-	-	250	
Gate-to-Emitter Leakage Current	I_{GES}	$V_{CE} = 0V, V_{GE} = \pm 20V$	-	-	100	nA
Gate Threshold Voltage	$V_{GE(th)}$	$V_{CE} = V_{GE}, I_C = 250\mu\text{A}$	5.0	6.0	7.0	V
Collector-to-Emitter Saturation Voltage	$V_{CE(sat)}$	$V_{GE} = 15V, I_C = 15A$	-	1.5	1.9	V
		$V_{GE} = 15V, I_C = 15A,$ $T_j = 125^\circ\text{C}$	-	1.8	-	
Diode Forward Voltage	V_F	$V_{GE} = 0V, I_F = 15A$	-	1.6	2.1	V
		$V_{GE} = 0V, I_F = 15A$ $T_j = 125^\circ\text{C}$	-	1.4	-	

Thermal Characteristics

Parameter	Symbol	Min	Typ	Max	Unit
Junction-to-Ambient Thermal Resistance (TO-263, TO-220)	R _{θJA}	-	-	62	°C/W
Junction-to-Ambient Thermal Resistance (TO-220MF)		-	-	65	
Junction-to-Case Thermal Resistance (TO-263, TO-220), IGBT	R _{θJC}	-	-	1.1	
Junction-to-Case Thermal Resistance (TO-263, TO-220), Diode		-	-	1.4	
Junction-to-Case Thermal Resistance (TO-220MF), IGBT		-	-	1.7	
Junction-to-Case Thermal Resistance (TO-220MF), Diode		-	-	2.4	

Dynamic Electrical Characteristics ⁽¹⁾

Parameter	Symbol	Test Conditions	Min	Typ	Max	Unit
Total Gate Charge	Q _g	V _{CC} = 400V, V _{GE} = 15V, I _C = 15A	-	45	-	nC
Input Capacitance	C _{iss}	V _{CE} = 25V, V _{GE} = 0V, f = 1MHz	-	930	-	pF
Output Capacitance	C _{oss}		-	85	-	
Reverse Transfer Capacitance	C _{rss}		-	16	-	

Switching Characteristics, Inductive Load ^{(1), (2)}

Parameter	Symbol	Test Conditions	Min	Typ	Max	Unit
Turn-on delay time	$t_{d(ON)}$	$V_{CC} = 400V,$ $V_{GE} = 0/15V,$ $R_G = 10\Omega,$ $I_C = 15A,$ $L_{load} = 3mH$ (Energy losses include "tail" and diode reverse recovery)	-	24	-	ns
Rise Time	t_r		-	19	-	
Turn-off delay time	$t_{d(OFF)}$		-	89	-	
Fall Time	t_f		-	70	-	
Turn-On Switching Loss	E_{on}		-	0.28	-	mJ
Turn-Off Switching Loss	E_{off}		-	0.28	-	
Total Switching Loss	E_{ts}		-	0.56	-	
Diode Reverse Recovery Time	t_{rr}		-	46	-	ns
Short Circuit Capability	t_{SC}	$V_{GE} = 15V,$ $V_{CC} \leq 400V,$ $V_P \leq 600V$	5	10	-	μs
Short Circuit Collector Current	$I_{C(SC)}$		-	60	-	A

(1) $T_j = 25^\circ C$ unless otherwise specified.

(2) t_r : from 10% of I_C to 90% of I_C ; t_f : from 90% of I_C to 10% of I_C ;

E_{on} : from 10% of V_{GE} to 10% of V_{CE} ; E_{off} : from 90% of V_{GE} to 10% of I_C .

(3) Limited by bonding wire(s).

Typical Electrical Characteristics

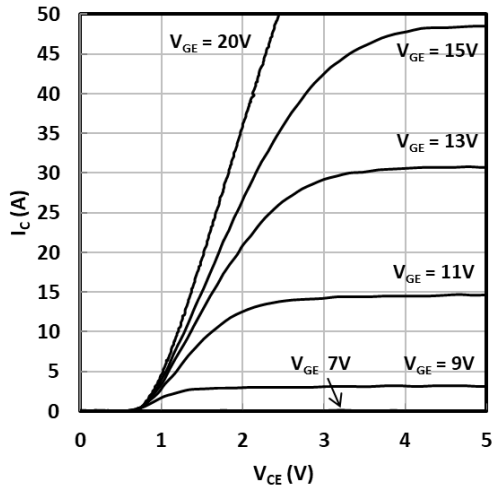

Fig. 1 Typical output characteristics

($T_j = 25^\circ\text{C}$, $t_p = 250 \mu\text{s}$)

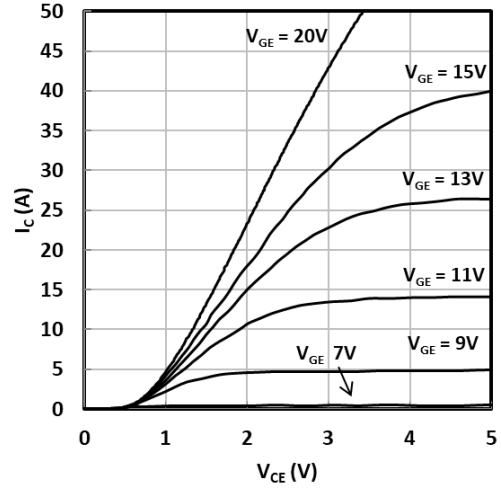

Fig. 2 Typical output characteristics

($T_j = 150^\circ\text{C}$, $t_p = 250 \mu\text{s}$)

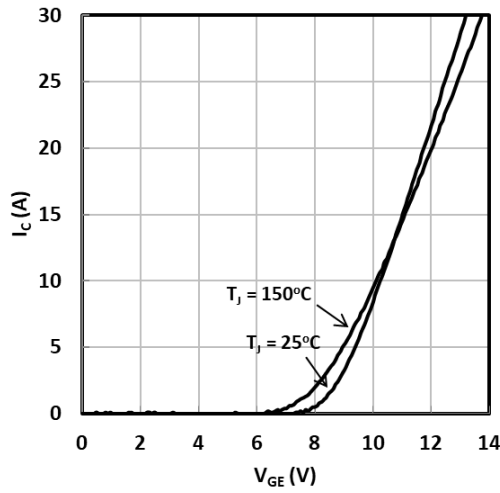

Fig. 3 Typical transfer characteristics

($V_{ce} = 20\text{V}$, $t_p = 250 \mu\text{s}$)

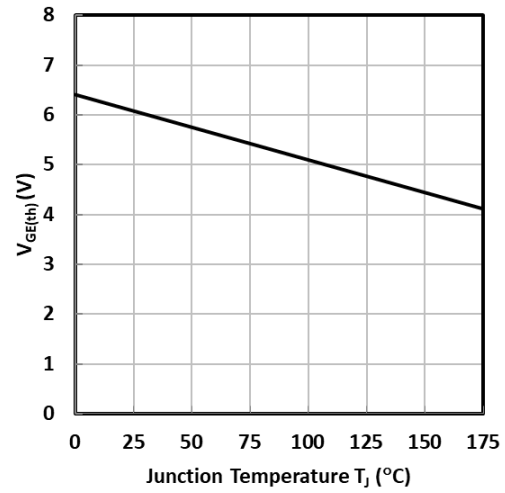

Fig. 4 Typical gate threshold voltage as a function of junction temperature

($V_{ce} = V_{ge}$, $I_c = 250 \mu\text{A}$)

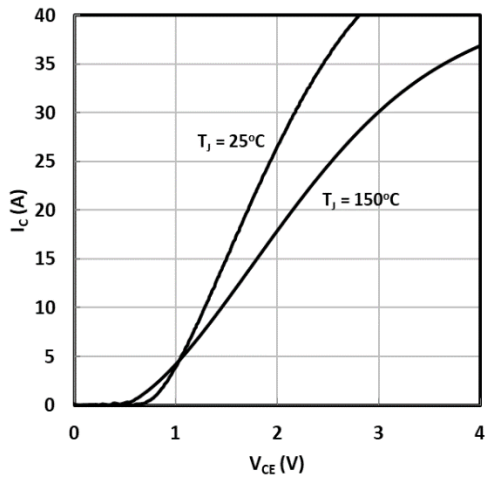

Fig. 5 Typical saturation voltage characteristics
($V_{GE} = 15\text{ V}$, $t_p = 250\ \mu\text{s}$)

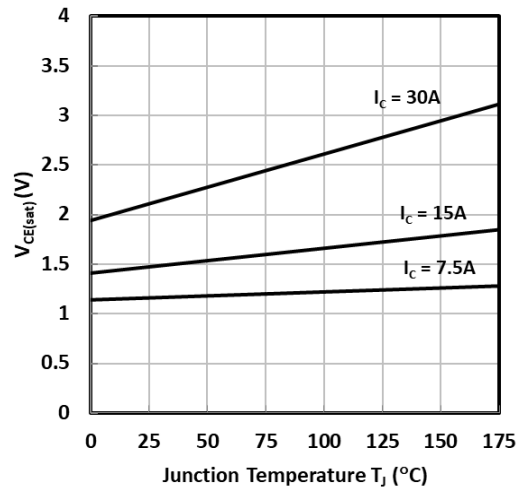

Fig. 6 Typical saturation voltage as a function of junction temperature
($V_{GE} = 15\text{ V}$, $t_p = 250\ \mu\text{s}$)

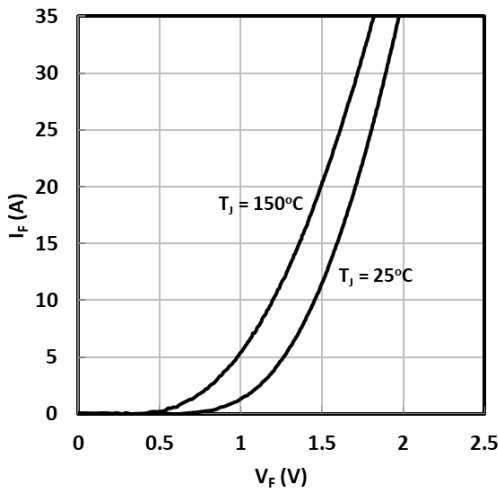

Fig. 7 Typical diode forward current as a function of forward voltage
($V_{GE} = 0\text{ V}$, $t_p = 250\ \mu\text{s}$)

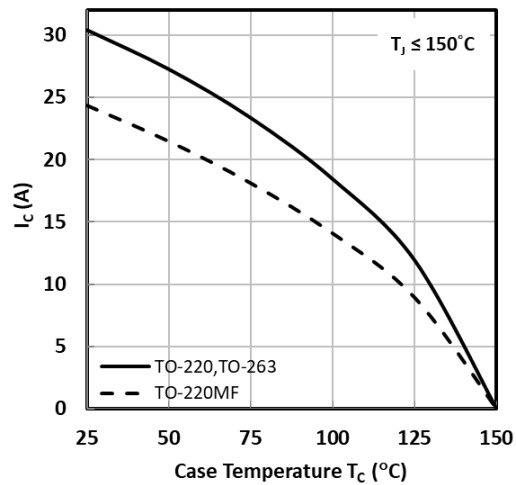

Fig. 8 Maximum DC collector current as a function of case temperature

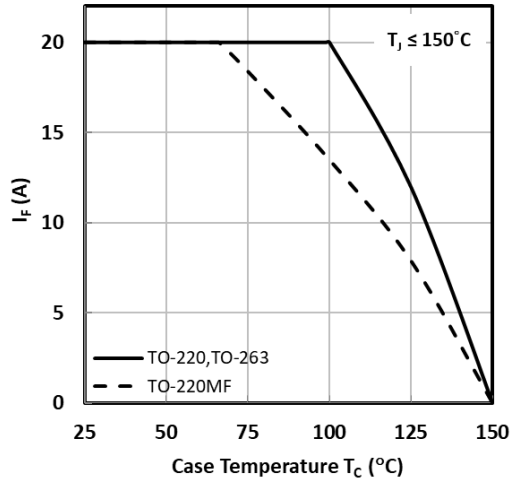

Fig. 9 Maximum DC diode forward current as a function of case temperature
(I_F limited by bonding wire)

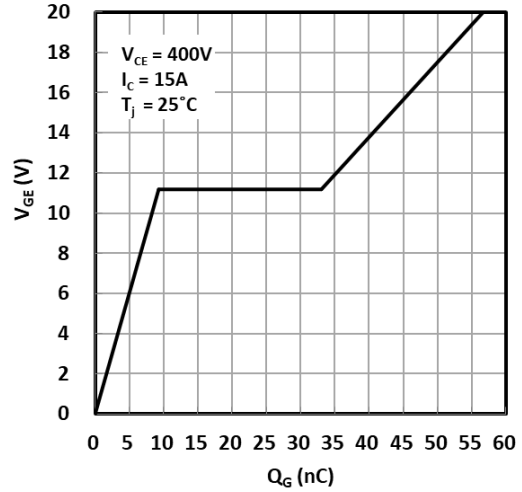

Fig. 10 Typical gate charge characteristics

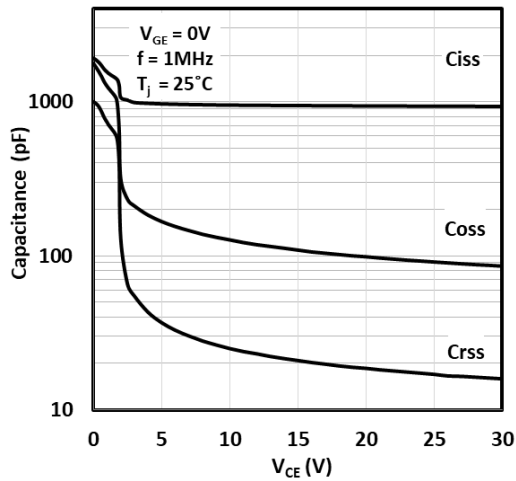
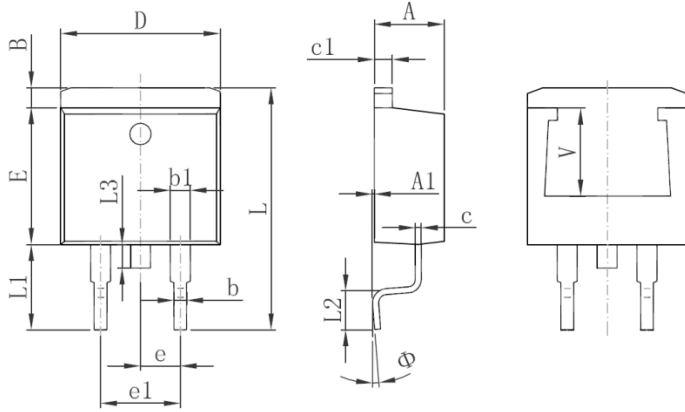

Fig. 11 Typical capacitance as a function of collector-to-emitter voltage

Package Drawing



Symbol	Dimensions In Millimeters	
	Min.	Max.
A	4.470	4.670
A1	0.000	0.150
B	1.120	1.420
b	0.710	0.910
b1	1.170	1.370
c	0.310	0.530
c1	1.170	1.370
D	10.010	10.310
E	8.500	8.900
e	2.540 TYP.	
e1	4.980	5.180
L	14.940	15.500
L1	4.950	5.450
L2	2.340	2.740
L3	1.300	1.700
Φ	0°	8°
V	5.600 REF.	

TO-263

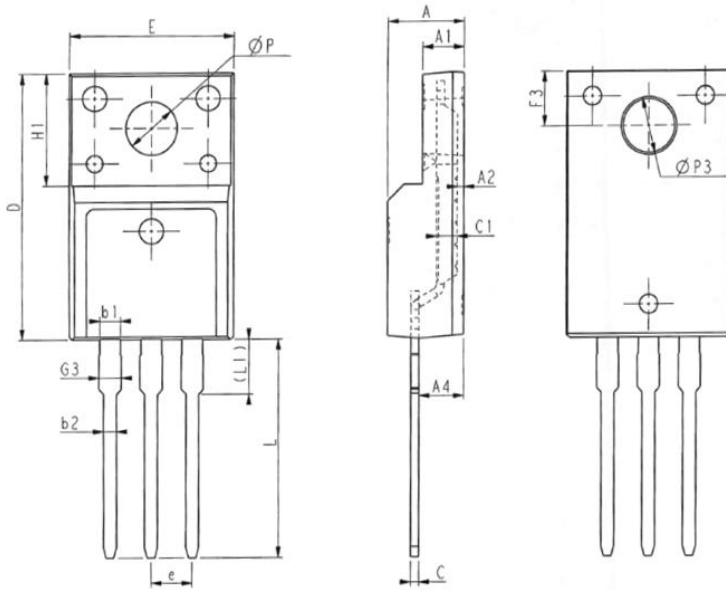

SYMBOL	MM		
	MIN	NOM	MAX
E	9.96	10.16	10.36
A	4.50	4.70	4.90
A1	2.34	2.54	2.74
A2	0.30	0.45	0.60
A4	2.56	2.76	2.96
c	0.40	0.50	0.65
c1	1.20	1.30	1.35
D	15.57	15.87	16.17
H1	6.70REF		
e	2.54BSC		
L	12.68	12.98	13.28
L1	3.03	3.23	3.43
ΦP	3.03	3.18	3.38
ΦP3	3.15	3.45	3.65
F3	3.15	3.30	3.45
G3	1.25	1.35	1.55
b1	1.18	1.28	1.43
b2	0.70	0.80	0.95

TO-220MF

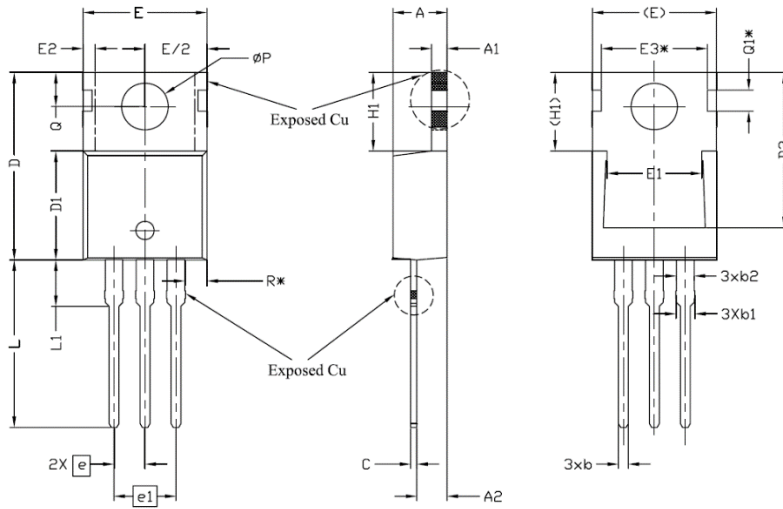

SYMBOL	DIMENSIONS		
	MIN.	NOM.	MAX.
A	4.24	4.44	4.64
A1	1.15	1.27	1.40
A2	2.30	2.48	2.70
b	0.70	0.80	0.90
b1	1.20	1.55	1.75
b2	1.20	1.45	1.70
c	0.40	0.50	0.60
D	14.70	15.37	16.00
D1	8.82	8.92	9.02
D2	12.63	12.73	12.83
E	9.96	10.16	10.36
E1	6.86	7.77	8.89
E2	-	-	0.76
E3*	8.70REF.		
e	2.54BSC		
e1	5.08BSC		
H1	6.30	6.45	6.60
L	13.47	13.72	13.97
L1	3.60	3.80	4.00
$\varnothing P$	3.75	3.84	3.93
Q	2.60	2.80	3.00
Q1*	1.73REF.		
R*	1.82REF.		

TO-220

Revision history of JHB15N60FE/JHG15N60FE/JHP15N60FE Specification

Version	Change Items	Effective Date
1.00	Initial Release.	23-Jul-20

Notice

General – Information in this document is believed to be accurate and reliable. However, JSAB Technologies does not give any representations or warranties, expressed or implied, as to the accuracy or completeness of such information and shall have no liability for the consequences of use of such information.

Right to make changes – JSAB Technologies reserves the right to make changes to information published in this document, including without limitation specifications and product descriptions, at any time and without notice. This document supersedes and replaces all information supplied prior to the publication hereof.

Suitability for use – JSAB Technologies' products are not designed, authorized or warranted to be suitable for use in medical, military, aircraft, space or life support equipment, nor in applications where failure or malfunction of an JSAB Technologies product can reasonably be expected to result in personal injury, death or severe property or environmental damage. JSAB Technologies accepts no liability for inclusion and/or use of JSAB Technologies' products in such equipment or applications and therefore such inclusion and/or use is at the customer's own risk.

Applications – Applications that are described herein for any of these products are for illustrative purposes only. JSAB Technologies makes no representation or warranty that such applications will be suitable for the specified use without further testing or modification.

Limiting values – Stress above one or more limiting values may cause permanent damage to the device. Limiting values are stress ratings only and operation of the device at these or any other conditions above those given in the Characteristics sections of this document is not implied. Exposure to limiting values for extended periods may affect device reliability.

Terms and conditions of sale – JSAB Technologies' products are sold subject to the general terms and conditions of commercial sale, including those pertaining to warranty, intellectual property rights infringement and limitation of liability, unless explicitly otherwise agreed to in writing by JSAB Technologies. In case of any inconsistency or conflict between information in this document and such terms and conditions, the latter will prevail.

No offer to sell or license – Nothing in this document may be interpreted or construed as an offer to sell products that is open for acceptance or the grant, conveyance or implication of any license under any copyrights, patents or other industrial or intellectual property rights.

Export control – This document as well as the item(s) described herein may be subject to export control regulations. Export might require a prior authorization from national authorities.

Quick reference data – The Quick reference data is an extract of the product data given in the Limiting values and Characteristics sections of this document, and as such is not complete, exhaustive or legally binding.